

Heritage® Reinforced Boxes

T12: Custom Reinforced Two-Piece Box

Assembly Instructions

- ① Place flat box white side facing up. The crease lines should be visible, and the blue/gray side of the board facing down.

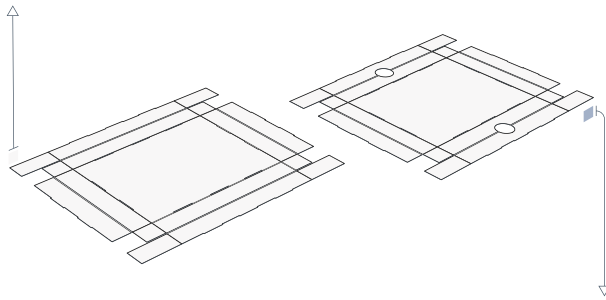

- ② Pre-crease all lines prior to snapping any walls into place. Pay extra attention to the double crease lines which are approximately 1/4" apart along doubled over the walls. It is critical that both crease lines are folded at a full 90° or more.

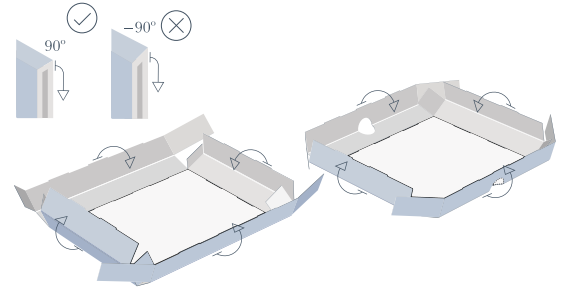

- ③ Fold up the two walls with the smaller inside flaps first. All flaps should be folded at 90°.

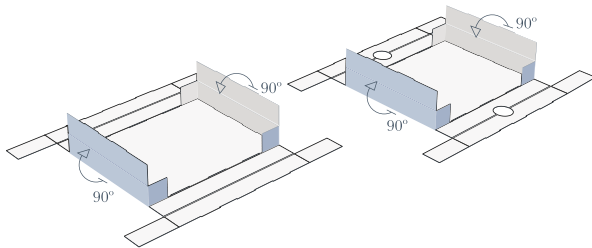

- ④ Fold up the perpendicular walls. The flaps attached to these walls fold at -90°. See step 2 about properly creasing these walls.

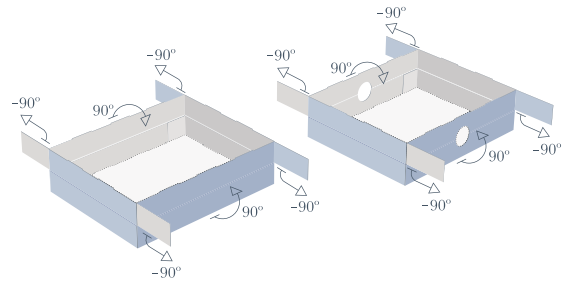

- ⑤ Snap the walls with the -90° flaps in place. You will see that these flaps are now flush along the perpendicular wall.

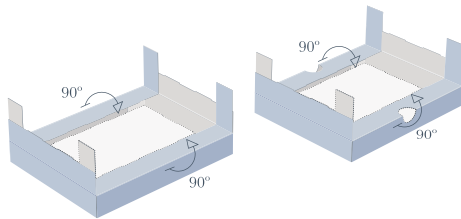

- ⑥ Fold the remaining two walls in place. The flaps from the two side walls should be sandwiched inside the wall and secure it in place. See step 2 about properly creasing these walls.

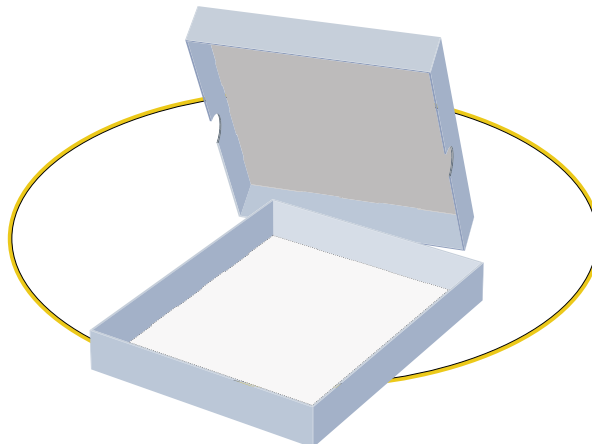
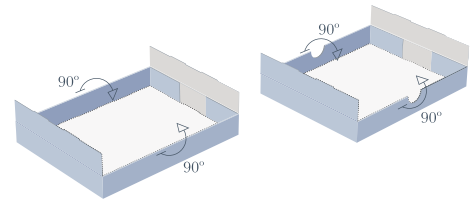

Related Products:

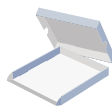

Heritage® Print Storage Boxes
T16: Custom Two-Piece Box

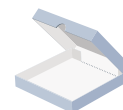

Heritage® Clamshell Box
T03: Custom Archival Clamshell Box